

20 CATALOGUE
22 KATALOG

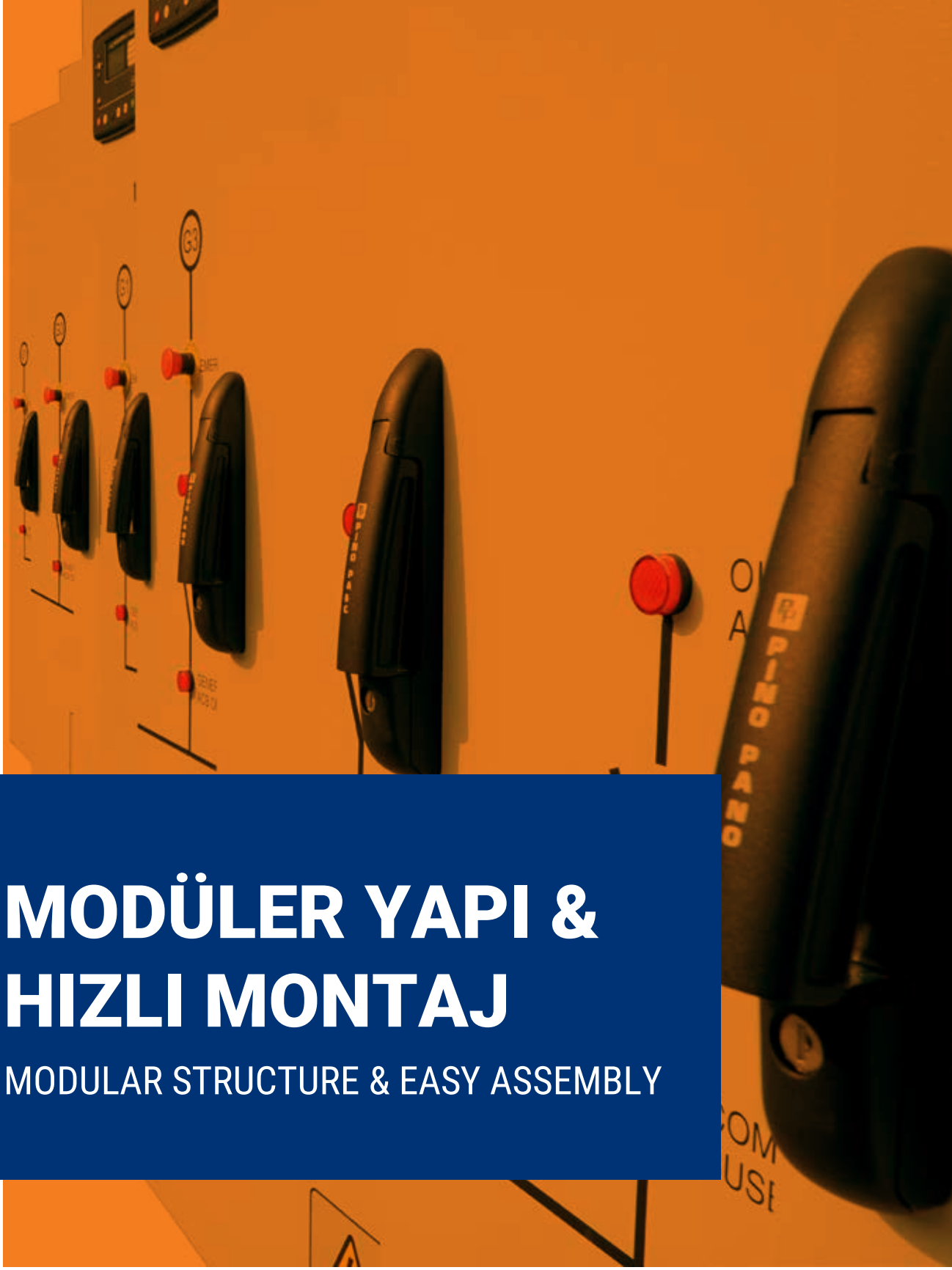

MODÜLER YAPI & HIZLI MONTAJ

MODULAR STRUCTURE & EASY ASSEMBLY

 **PINO PANO**



Hakkımızda / About Us

1987 Yılında serüvenine başlayan firmamız faaliyetlerine endüstriyel otomasyon işleri yaparak başlamış olup, 1995 yılından itibaren çalışma alanına alt yapı tesisleri kurulumu da eklemiştir.

2000 yılında ISO-9001 sistemini kurup kurumsallaşarak Endüstriyel alanda fabrikaların zayıf akım tesislerinin ve pano elektromontajlarının alt yapılarını anahtar teslimi kurulumlarını ve makine otomasyonları ile birlikte yapmaya devam etmiştir.

2007 yılında Otomasyon ve Taahhüt alanındaki tecrübe ve birikimlerini birleştirerek PİNO PANO markası ile elektrik panolarının sac aksamlarını da üretmeye başlamıştır. AR-GE ve ürün geliştirmeye önem veren firmamız kısa sürede kendi patenti altına birçok ürün kazandırarak, AR-GE destek programlarının da yardımıyla tesisini teknolojik olarak yenilemiştir.

2016 yılında kazandığı hacim ile PİNO PANO markası Pino Pano Metal San. Ve Müh. A.Ş. Adıyla ayrı bir şirkete dönüşmüştür.

Bugün Firmamız gerekli bütün sertifikasyona sahip, gelişmiş üretim parkuru ve toplamda 4.000 metrekarelik alanıyla yüksek kalite ve kısa teslim süresi ilkesi ile her türlü ihtiyaca göre çözümler sunup, yüksek müşteri memnuniyeti hedefi ile ilerlemeye devam etmektedir.

Our company, which started its adventure in 1987, started its activities by doing industrial automation works, and since 1995, it has added infrastructure facilities to its working area.

By establishing and institutionalizing the ISO-9001 system in 2000, it continued to make the infrastructure of weak current facilities and panel electroassemblies of the factories in the industrial field, together with the turnkey installations and machine automations.

2007, by combining its experience and knowledge in the field of Automation and Contracting, it started to produce sheet metal parts of electrical panels with the brand PİNO PANO.

Our company, which attaches importance to R&D and product development, has brought many products under its own patent in a short time and renewed its facility technologically with the help of R&D support programs.

With the volume it gained in 2016, PİNO PANO brand Pino Pano Metal San. and Eng. Inc. It has transformed into a separate company with its name.

Today, our company continues to progress with the goal of high customer satisfaction by offering solutions according to all kinds of needs with the principle of high quality and short delivery time, with all the necessary certification, advanced production track and a total area of 4,000 square meters.



IEC 61439-2

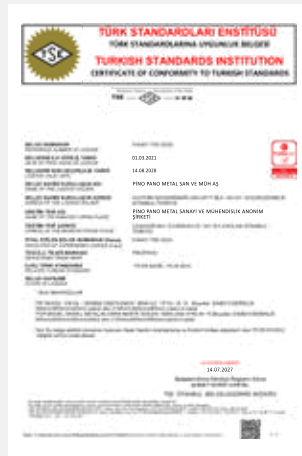

IEC 62208



IEC 60670-24



ISO 9001:2015



Gost-R (EAC)

İÇİNDEKİLER



sayfa 6

**Modüler Dikili Tip
Dahili Panolar**
(PSM Serisi)

**Modular Floor Standing
Type Indoor Enclosures**
(PSM Series)



sayfa 12

**Modüler Dikili Tip
Harici Panolar** (PSH Serisi)

**Modular Floor Standing Type
Outdoor Enclosures** (PSH Series)



sayfa 13

**Kaynaklı Dikili Tip
Dahili Panolar** (PSK Serisi)

**Monoblock Floor Standing Type
Indoor Enclosures** (PSK Series)



sayfa 16

Yarı Modüler Kutular
(PMY Serisi)

Semi Modular Boxes
(PMY Series)



sayfa 22

Harici Kutular
(PMH Serisi)

Outdoor Boxes
(PMH Series)



sayfa 23

Kaynaklı Kutular
(PMK Serisi)

Monoblock Boxes
(PMK Series)

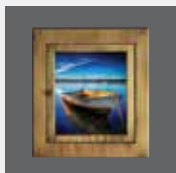
**sayfa 26****Kaynaklı Dikili Tip Kutular** (PMS Serisi)
Monoblock Floor Standing Type Boxes
(PSM Series)**sayfa 34****Kaynaklı Dikili Tip Sayaç Panoları**
(PSK S Serisi)
Monoblock Floor Standing Type Meter Panels
(PSK S Series)**sayfa 28****Sıva Altı Kutular** (PMA Serisi)
Flush Mounted Boxes (PMA Series)**sayfa 35****Duvar Tipi Sayaç Kutuları** (PMK S Serisi)
Monoblock Meter Boxes (PMK S Series)**sayfa 30****Daire Panoları** (PMD Serisi)
Boxes for Residences (PMD Series)**sayfa 36****Piyano Panolar** (PPY T Serisi)
Piano Type Enclosures (PPY T Series)**sayfa 31****Dekoratif Sıva Altı Kutular** (PMF Series)
Decorative Flush Mounted Boxes (PMF Series)**sayfa 38****Pult Tipi Piyano Panolar** (PPT T Serisi)
Pult Piano Type Enclosures (PPT T Series)**sayfa 32****Buat Kutuları** (PBK T Serisi)
Terminal Boxes (PBK T Series)**sayfa 40****Operatör Kollar & Paneller**
Panel Holders**sayfa 33****Şantiye Panoları** (PMH S Serisi)
Construction Boards (PMH S Series)**sayfa 44****Aksesuarlar**
Accessories

Modüler Dikili Tip Dahili Panolar (PSM Serisi)

Modular Floor Standing Type Indoor Enclosures (PSM Series)



ÖZELLİKLER

- Modüler karkas yapısı
- IP54'e kadar koruma
- IEC 61439-2 ve IEC 62208 standartlarına uygun
- Galvaniz kaplı çelik;
Karkas: 2mm / Boyasız
Kapı: 1.5mm / Ral 7035 Boyalı
Arka-Yan Kapak: 1mm / Ral 7035 Boyalı
Baza: 2mm / Ral 9005 Boyalı

STANDART AKSESUARLAR

- Taşıyıcı mapa
- İspanyolet kilit sistemi ve gizli menteşe sistemi
- Projecebi
- Poliüretan Conta
- Alüminyum kablo giriş fırçası

Ek aksesuarlar; 03-04-08-14-15-16-17-18-19-20-21-22-23

FEATURES

- Modular structure
- Up to IP54 protection
- Compatible with IEC 61439-1/2 ve IEC 62208 standards
- Galvanized Steel;
Structure: 2mm / unpainted
Front Door: 1.5mm / Ral 7035 painted
Back-Side Covers: 1mm / Ral 7035 painted
Base carrier: 2mm / Ral 9005 painted

STANDARD ACCESSORIES

- Transport Lug
- Espagnolette Lock system and concealed hinge system
- Document pocket
- Polyurethan Gasket
- Aluminium cable entry brush

Addible Accesories; 03-04-08-14-15-16-17-18-19-20-21-22-23



Çekmeceli kompanzasyon modülü
Withdrawable compensation module



4 noktadan kilitleyen güvenli kilit sistemi
4 point secure locking system



Modüler alt kapama sistemi
Modular bottom covers



Form 4B'ye kadar formlama seçeneği
Partition option up to Form 4B



Poliüretan conta ile yüksek sızdırmazlık
Great sealing with polyurethane gasket



Farklı kapı seçenekleri
Different door options

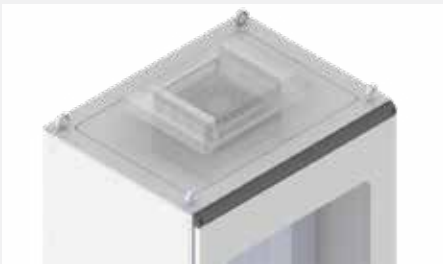

Tepe fan modülü eklentisi
Roof fan addition



Kapak bölme seçenekleri
Door seperation options

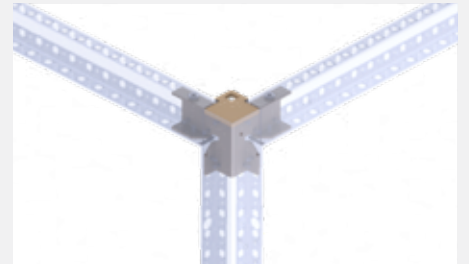

Profili mükemmel saran köşe birleşim sistemi
Corner connection that perfectly surrounds profile

Modüler Dikili Tip Dahili Taban Saclı Panolar (PSM T Serisi)

Modular Floor Standing Type Indoor Base Plated Enclosures (PSM T Series)



ÖZELLİKLER

- Galvaniz kaplı çelik;
Taban sacı: 2mm / Boyasız
Taşıyıcı parçalar: 2mm/ Boyasız

FEATURES

- Galvanized Steel;
Base plate: 2mm / unpainted
Internal parts: 2mm / unpainted





Taban sacı montaj şekli ve hareket kabiliyeti
Base plate mounting types and moving range

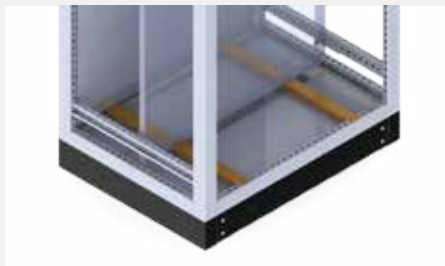

Taban sacı taşıma kızakları
Base plate carrier slides

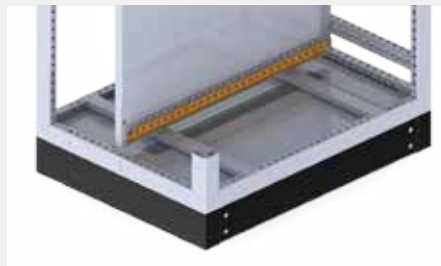

Kablo sabitleme
Cable fixing

Kabin Yüksekliği Enclosure Height	Taban Sacı Yüksekliği Base Plate Height
180cm	159cm
210cm	189cm
Kabin Genişliği Enclosure Width	Taban Sacı Genişliği Base Plate Width
60cm	53cm
80cm	73cm

Modüler Dikili Tip Dahili Örtü Sacı Panolar (PSM 0 Serisi)

Modular Floor Standing Type Indoor Cover Plated Enclosures (PSM 0 Series)



ÖZELLİKLER

- Galvaniz kaplı çelik;
Perde sacı: 1mm / Ral 7035 Boyalı
Taşıyıcı parçalar: 2mm/ Boyasız

FEATURES

- Galvanized Steel;
Cover plate: 1mm / Ral 7035 painted
Internal parts: 2mm / unpainted

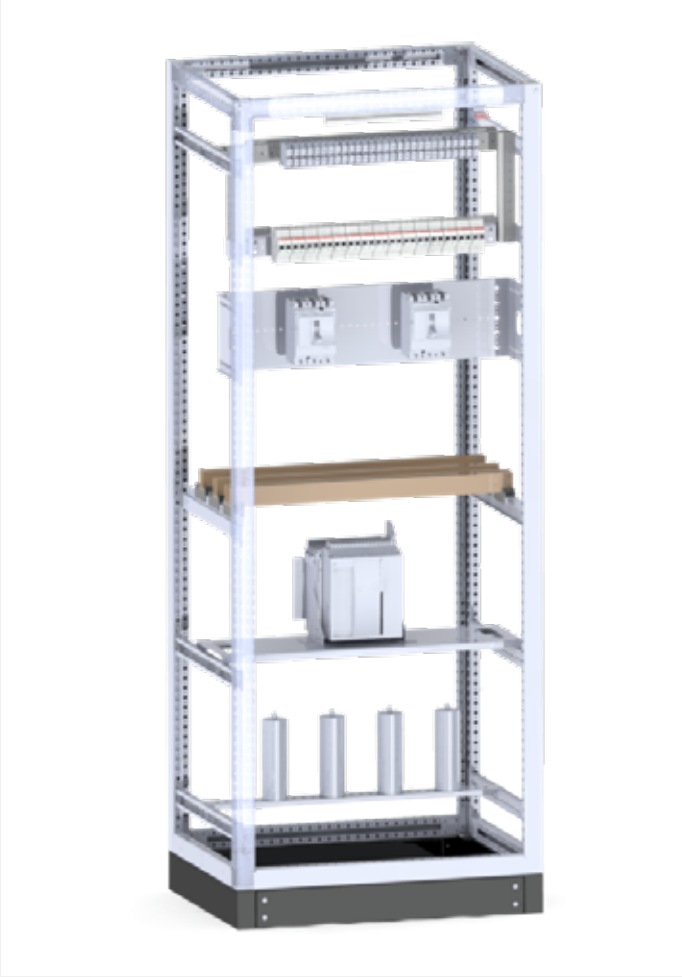

İç parça sistemi
Internal part system



Perde sacı sistemi
Cover plate system

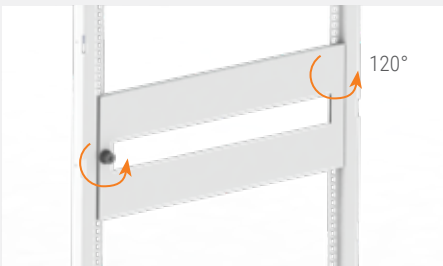

Menteşeli perde sacı, bütün pano serilerinde ortak kullanım
Hinged cover plate, common use in all series

Kabin Yüksekliği Enclosure Height		
180cm		
210cm		
Perde Sacı Toplam Yüksekliği Cover Plate Total Height	Kabin Genişliği Enclosure Width	Sigorta Adetleri MCB Units
155cm	60cm	24
185cm	80cm	36

Modüler Dikili Tip Harici Panolar (PSH Serisi)

Modular Floor Standing Type Outdoor Enclosures (PSH Serisi)



Şapka eklentisi
Roof addition



Dışarıdan erişimi kesen arka-yan kapak ve şapka eklentisi
Back-side cover and roof addition that cuts off access from the outside



PS serisi iç parçaları ile uyumlu
Compatible with PS series internal parts



Tepe fan modülü eklentisi
Roof fan addition



Filtre koruma kapağı
Filter protection cover

ÖZELLİKLER

- Modüler karkas yapısı
- IP65'e kadar koruma
- Galvaniz kaplı çelik;
Karkas: 2mm / Ral 7035 boyalı
Arka-Yan Kapak: 1.2mm / Ral 7035 boyalı
Baza: 2mm / Ral 9005 Boyalı

FEATURES

- Modular structure
- Up to IP65 protection
- Galvanized Steel;
Structure: 2mm / Ral 7035 painted
Front Door: 1.5mm / Ral 7035 painted
Back-Side Covers: 1.2mm / Ral 7035 painted
Base carrier: 2mm / Ral 9005 painted

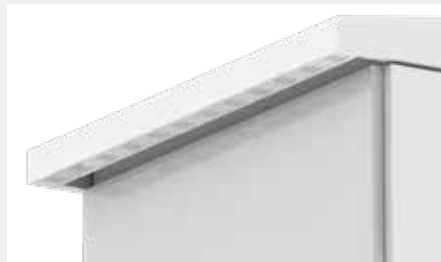

Şapka alt yüzeyinden doğal havalandırma
Natural ventilation on lower surface of roof



Panjur havalandırma seçeneği
Formed blinds options

Kaynaklı Dikili Tip Dahili Panolar (PSK Serisi)

Monoblock Floor Standing Type Indoor Enclosures (PSK Series)



PS serisi iç parçaları ile uyumlu
Compatible with PS series internal parts

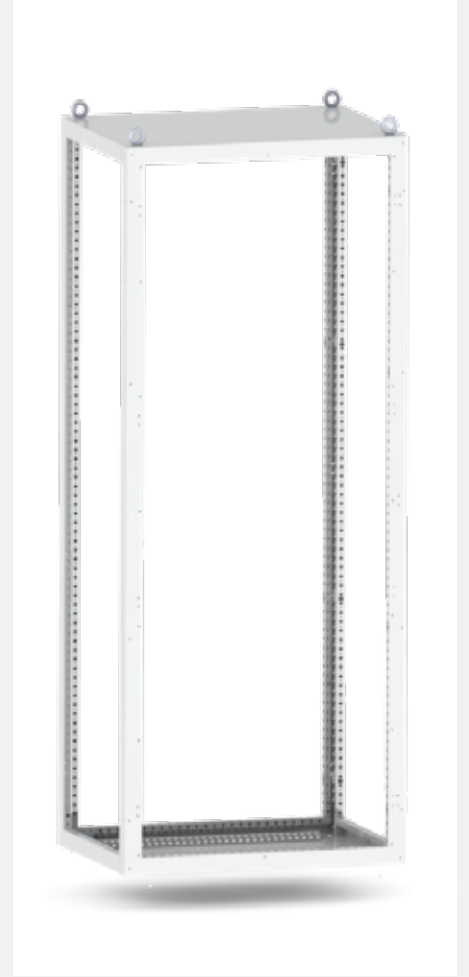

Kaynaklı, boyalı ve daha hafif karkas
Welded, painted body and lighter structure

ÖZELLİKLER

- Monoblok Karkas yapısı
- IP41'e kadar koruma
- IEC 61439-2 ve IEC 62208 standartlarına uygun
- Galvaniz kaplı çelik;
Karkas: 1.2mm / Ral 7035 Boyalı
Kapı: 1.2mm / Ral 7035 Boyalı
Arka-Yan Kapak: 1mm / Ral 7035 Boyalı
Baza: 2mm / Ral 9005 Boyalı



Monoblok üst kapak
Monoblock Top cover

FEATURES

- Monoblock structure
- Up to IP41 protection
- Compatible with IEC 61439-1/2 ve IEC 62208 standards
- Galvanized Steel;
Structure: 1.2mm / unpainted
Front Door: 1.2mm / Ral 7035 painted
Back-Side Covers: 1mm / Ral 7035 painted
Base carrier: 2mm / Ral 9005 painted

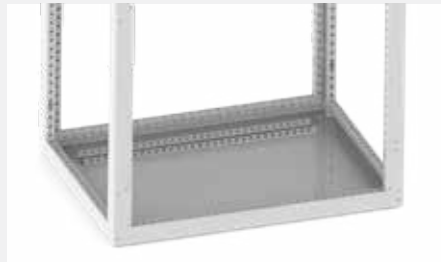

Monoblok ve sabit alt kapama
Monoblock and fixed bottom cover



Kaynaklı karkas yapısı
Welded structure

PS Serisi Kod ve Ölçülendirme Detayı

PS Series Code and Dimensioning Details

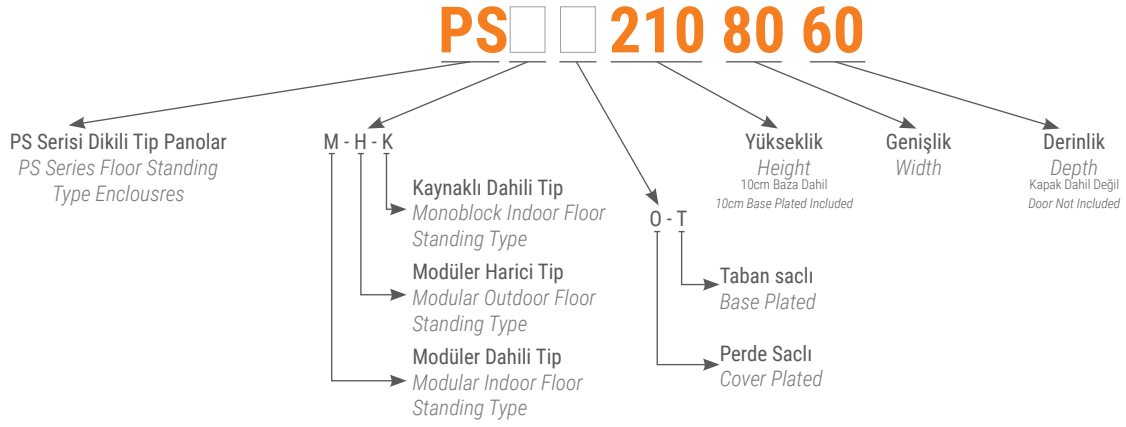

PS Serisi Standart Pano Ölçü ve Kodları

PS Series Standard Enclosure Dimensions and Codes

Ürün Kodu Product Code	Yükseklik Height	Genişlik Width	Derinlik Depth
1804040	1800 mm	400 mm	400 mm
1804050			500 mm
1804060			600 mm
1804070			700 mm
1804080			800 mm
1805040		500 mm	400 mm
1805050			500 mm
1805060			600 mm
1805070			700 mm
1805080			800 mm
1806040		600 mm	400 mm
1806050			500 mm
1806060			600 mm
1806070			700 mm
1806080			800 mm
1807040		700 mm	400 mm
1807050			500 mm
1807060			600 mm
1807070			700 mm
1807080			800 mm
1808040		800 mm	400 mm
1808050			500 mm
1808060			600 mm
1808070			700 mm
1808080			800 mm

Ürün Kodu Product Code	Yükseklik Height	Genişlik Width	Derinlik Depth
2104040	2100 mm	400 mm	400 mm
2104050			500 mm
2104060			600 mm
2104070			700 mm
2104080			800 mm
2105040		500 mm	400 mm
2105050			500 mm
2105060			600 mm
2105070			700 mm
2105080			800 mm
2106040		600 mm	400 mm
2106050			500 mm
2106060			600 mm
2106070			700 mm
2106080			800 mm
2107040		700 mm	400 mm
2107050			500 mm
2107060			600 mm
2107070			700 mm
2107080			800 mm
2108040		800 mm	400 mm
2108050			500 mm
2108060			600 mm
2108070			700 mm
2108080			800 mm

Yarı Modüler Kutular (PMY Serisi)

Semi Modular Boxes (PMY Series)

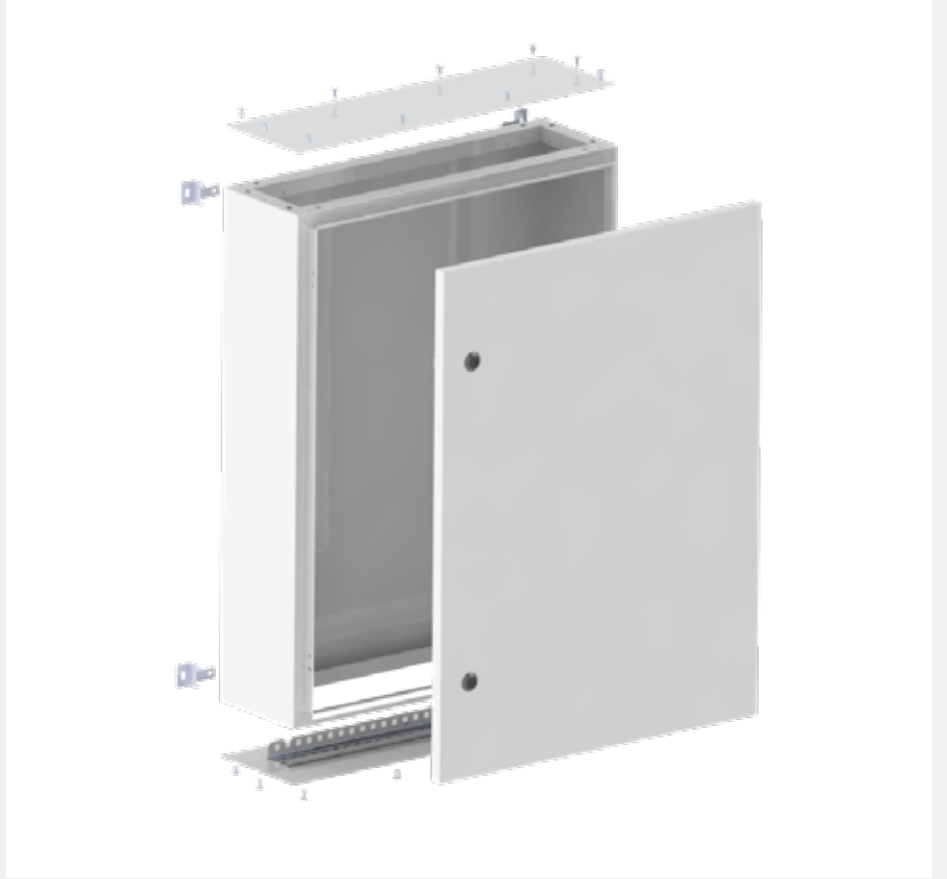

ÖZELLİKLER

- Yarı modüler gövde yapısı
- IP54'e kadar koruma
- IEC 61439-2 ve IEC 62208 standartlarına uygun
- Galvaniz kaplı çelik;
Gövde: 1-1.5mm / Ral 7035 Boyalı
Ön Kapak: 1-1.5mm / Ral 7035 Boyalı

STANDART AKSESUARLAR

- Taşıma kulakları
- Çeyrek dönüşlü zamak kilit ve gizli menteşe sistemi
- Projecebi
- Poliüretan Conta
- Alüminyum kablo giriş fırçası

Ek aksesuarlar; 03-04-09-10-11-12-14-15-16-17-18-19-20-23

FEATURES

- Semi modular structure
- Up to IP54 protection
- Compatible with IEC 61439-1/2 ve IEC 62208 standards
- Galvanized Steel;
Body: 1-1.5mm / Ral 7035 painted
Front Door: 1-1.5mm / Ral 7035 painted

STANDARD ACCESSORIES

- Carrier ears
- Quarter turn Lock and concealed hinge system
- Document pocket
- Polyurethan Gasket
- Aluminium cable entry brush

Addible Accesories; 03-04-09-10-11-12-14-15-16-17-18-19-20-23



Modüler alt-üst kapak
Modular top-bottom cover

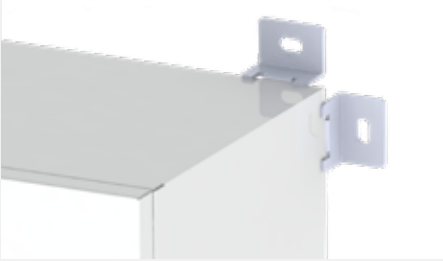

Pano taşıma kulakları
Carrier ears

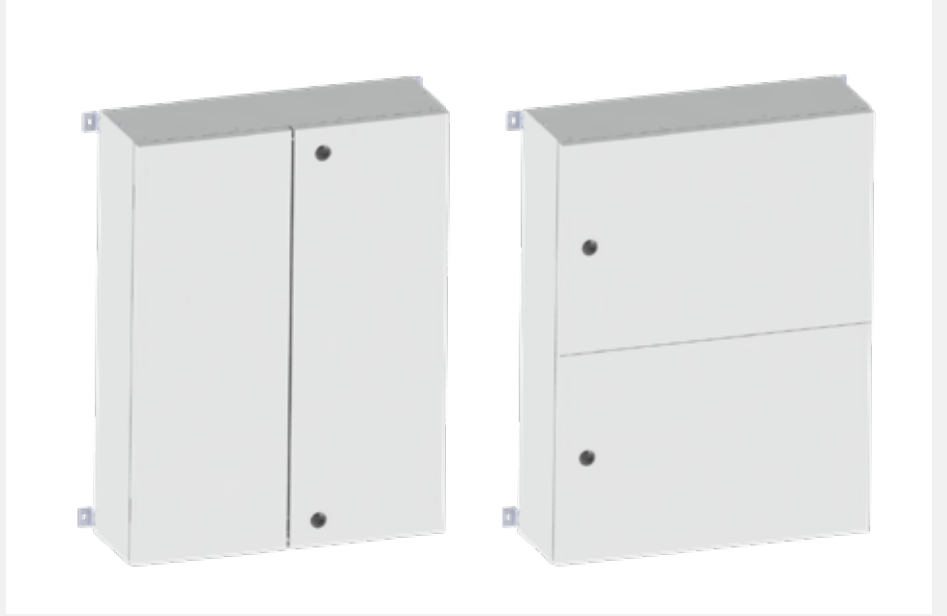

Kapak bölme seçenekleri
Door separation options



Çeyrek dönüşlü kilit
Quarter turn lock



Farklı kapı seçenekleri
Different types of doors



Poliüretan conta ile yüksek sızdırmazlık
Great sealing with polyurethane gasket

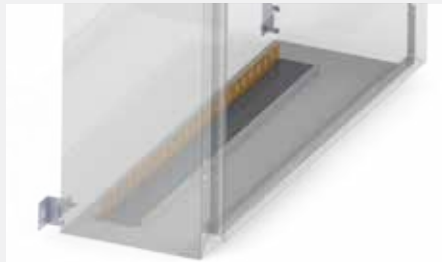

Kablo sabitleme
Cable fixing



Baza ekleme seçeneği
Base carrier addition

Yarı Modüler Taban Sacı Kutular (PMY T Series)

Semi Modular Base Plated Boxes (PMY T Series)



ÖZELLİKLER

- Galvaniz kaplı çelik;
- Taban sacı: 1-1.5mm / Boyasız
- Taşıyıcı parçalar: 1.5-2mm/ Boyasız

FEATURES

- Galvanized Steel;
- Base plate: 1.5mm / unpainted
- Internal parts: 2mm / unpainted



Taban sacı montaj şekli
Base plate mounting type



Kutu dışında montaj imkanı
Ability of mounting outside of the box

Kutu Yüksekliği Box Height	Taban Sacı Yüksekliği Base Plate Height	Kutu Genişliği Box Width	Taban Sacı Genişliği Base Plate Width
800cm	79cm	60cm	53cm
100cm	99cm	80cm	73cm

Yarı Modüler Örtü Sacı Kutular (PMY 0 Serisi)

Semi Modular Cover Plated Boxes (PMY 0 Series)



ÖZELLİKLER

- Galvaniz kaplı çelik;
- Perde sacı: 1mm / Ral 7035 Boyalı
- Taşıyıcı parçalar: 1.5mm/ Boyasız

FEATURES

- Galvanized Steel;
- Cover plate: 1mm / Ral 7035 painted
- Internal parts: 1.5mm / unpainted



Perde sacı ve iç parça montaj şekli
Cover plate and internal parts type



Kutu dışında montaj imkanı
Ability of mounting outside of the box

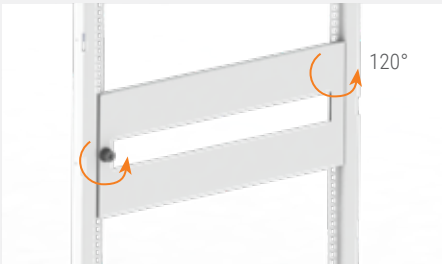

Menteşeli perde sacı, bütün pano serilerinde ortak kullanım
Hinged cover plate, common use in all series

Kutu Yüksekliği Box Height	Perde Sacı Toplam Yükseliği Cover Plate Total Height
80cm	75cm
100cm	95cm
Kutu Genişliği Box Width	Sigorta Adetleri MCB Units
60cm	24
80cm	36

Harici Kutular (PMH Serisi)

Outdoor Boxes (PMH Series)



Duvara monte harici kutu
Wall mounted type outdoor box



Zemine monte harici kutu
Ground mounted type outdoor box

ÖZELLİKLER

- Yarı modüler gövde yapısı
- IP65'e kadar koruma
- IEC 61439-2 ve IEC 62208 standartlarına uygun
- Galvaniz kaplı çelik;
Gövde: 1-1.5mm / Ral 7035 Boyalı
Ön Kapak: 1-1.5mm / Ral 7035 Boyalı

FEATURES

- Semi modular structure
- Up to IP65 protection
- Galvanized Steel;
Body: 1-1.5mm / Ral 7035 painted
Front Door: 1-1.5mm / Ral 7035 painted

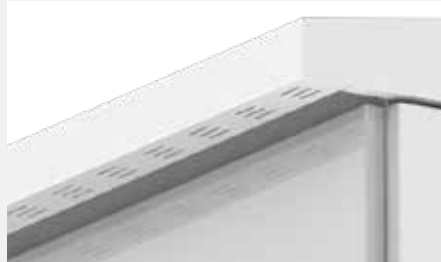

Şapka alt yüzeyinden doğal havalandırma
Natural ventilation on lower surface of roof

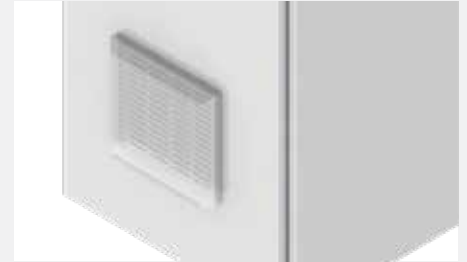

Filtre koruma kapağı
Filter protection cover

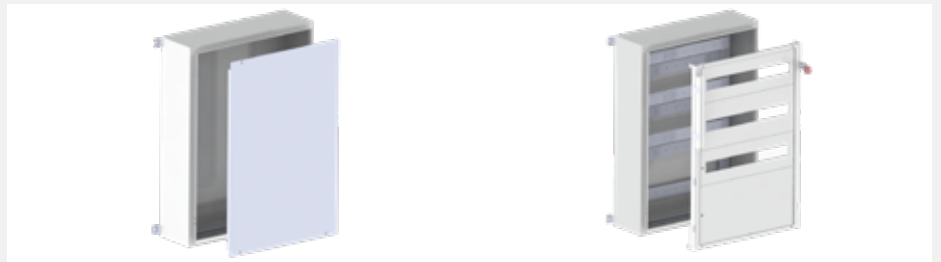

PM serisi iç parçaları ile uyumlu
Compatible with PM series internal parts

Kaynaklı Kutular (PMK Serisi)

Monoblock Boxes (PMK Series)



ÖZELLİKLER

- Monoblok gövde yapısı
- IP65'e kadar koruma
- IEC 61439-2 ve IEC 62208 standartlarına uygun
- Galvaniz kaplı çelik;
Gövde: 1-1.5mm / Ral 7035 Boyalı
Ön Kapak: 1-1.5mm / Ral 7035 Boyalı

FEATURES

- Monoblock structure
- Up to IP65 protection
- Galvanized Steel;
Body: 1-1.5mm / Ral 7035 painted
Front Door: 1-1.5mm / Ral 7035 painted



PM serisi iç parçaları ile uyumlu
Compatible with PM series internal parts



Kaynaklı gövde yapısı
Welded body structure

PM Serisi Kod ve Ölçülendirme Detayı

PM Series Code and Dimensioning Details

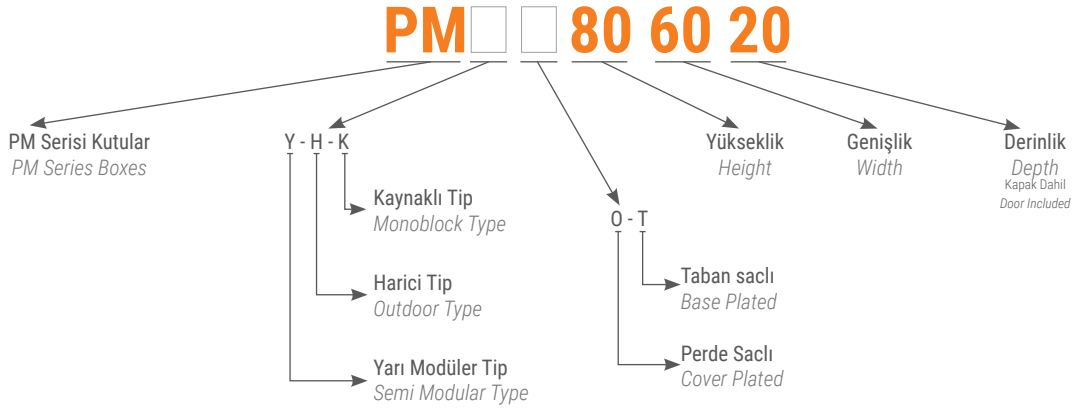

PM Serisi Standart Kutu Ölçü ve Kodları

PM Series Standard Box Dimensions and Codes

Ürün Kodu Product Code	Yükseklik Height	Genişlik Width	Derinlik Depth	
404020	400 mm	400 mm	200 mm	
404025			250	
404030			300 mm	
604020	600 mm	400 mm	200 mm	
604025			250	
604030			300 mm	
605020		500 mm	200 mm	
605025			250	
605030			300 mm	
804020	800 mm	400 mm	200 mm	
804025			250	
804030			300 mm	
805020		500 mm	200 mm	
805025			250	
805030			300 mm	
806020		600 mm	200 mm	
806025			250	
806030			300 mm	
1004020		1000 mm	400 mm	200 mm
1004025				250
1004030				300 mm
1005020	500 mm		200 mm	
1005025			250	
1005030			300 mm	
1006020	600 mm		200 mm	
1006025			250	
1006030			300 mm	
1007020	700 mm		200 mm	
1007025			250	
1007030			300 mm	
1008020	800 mm		200 mm	
1008025			250	
1008030			300 mm	

Ürün Kodu Product Code	Yükseklik Height	Genişlik Width	Derinlik Depth	
1204020	1200 mm	400 mm	200 mm	
1204025			250	
1204030			300 mm	
1205020	500 mm	500 mm	200 mm	
1205025			250	
1205030			300 mm	
1206020	600 mm	600 mm	200 mm	
1206025			250	
1206030			300 mm	
1207020	700 mm	700 mm	200 mm	
1207025			250	
1207030			300 mm	
1208020	800 mm	800 mm	200 mm	
1208025			250	
1208030			300 mm	
1404020	1400 mm	400 mm	200 mm	
1404025			250	
1404030			300 mm	
1405020		500 mm	500 mm	200 mm
1405025				250
1405030				300 mm
1406020		600 mm	600 mm	200 mm
1406025				250
1406030				300 mm
1407020		700 mm	700 mm	200 mm
1407025				250
1407030				300 mm
1408020		800 mm	800 mm	200 mm
1408025				250
1408030				300 mm

Kaynaklı Dikili Tip Kutular (PMS Serisi)

Monoblock Floor Standing Type Boxes (PMS Series)

ÖZELLİKLER

- Monoblok gövde yapısı
- IP54'e kadar koruma
- IEC 61439-2 ve IEC 62208 standartlarına uygun
- Galvaniz kaplı çelik;
Gövde: 1.5mm / Ral 7035 Boyalı
Ön Kapak: 1.5mm / Ral 7035 Boyalı
Baza: 2mm / Ral 7035 boyalı

STANDART AKSESUARLAR

- Taşıyıcı mapa
- İspanyolet kilit sistemi ve gizli menteşe sistemi
- Projecebi
- Alüminyum kablo giriş fırçası

Ek aksesuarlar; 03-04-08-09-10-14-15-16-17-18-19-20-23

FEATURES

- Monoblock structure
- Up to IP54 protection
- Galvanized Steel;
Body: 1.5mm / Ral 7035 painted
Front Door: 1.5mm / Ral 7035 painted
Base carrier: 2mm / Ral 7035 painted

STANDARD ACCESSORIES

- Transport Lug
- Espagnolette Lock system and concealed hinge system
- Document pocket
- Aluminium cable entry brush

Addible Accesories; 03-04-08-09-10-14-15-16-17-18-19-20-23



30cm ve daha kısa derinlikteki dikili tip pano ihtiyaçlarına uygun
Suitable for the needs of 30cm and shorter depth floor standing enclosures



Panonun devrilmesini engelleyen baza tipi
Base carrier type that prevents the enclosure from fall over



PM serisi iç parçaları ile uyumlu
Standard internal parts of PM series



Farklı kapı seçenekleri
Different door options

PMS Serisi Standart Pano Ölçü ve Kodları

PMS Series Standard Enclosure Dimensions and Codes

Ürün Kodu Product Code	Yükseklik Height	Genişlik Width	Derinlik Depth
1604020	1600 mm	400 mm	200 mm
1604025			250 mm
1604030			300 mm
1605020		500 mm	200 mm
1605025			250 mm
1605030			300 mm
1606020		600 mm	200 mm
1606025			250 mm
1606030			300 mm
1607020		700 mm	200 mm
1607025			250 mm
1607030			300 mm
1608020	800 mm	200 mm	
1608025		250 mm	
1608030		300 mm	
1804020	1800 mm	400 mm	200 mm
1804025			250 mm
1804030			300 mm
1805020		500 mm	200 mm
1805025			250 mm
1805030			300 mm
1806020		600 mm	200 mm
1806025			250 mm
1806030			300 mm

Ürün Kodu Product Code	Yükseklik Height	Genişlik Width	Derinlik Depth
1807020	1800 mm	700 mm	200 mm
1807025			250 mm
1807030			300 mm
1808020		800 mm	200 mm
1808025			250 mm
1808030			300 mm
2104020	2100 mm	400 mm	200 mm
2104025			250 mm
2104030			300 mm
2105020		500 mm	200 mm
2105025			250 mm
2105030			300 mm
2106020		600 mm	200 mm
2106025			250 mm
2106030			300 mm
2107020		700 mm	200 mm
2107025			250 mm
2107030			300 mm
2108020	800 mm	200 mm	
2108025		250 mm	
2108030		300 mm	

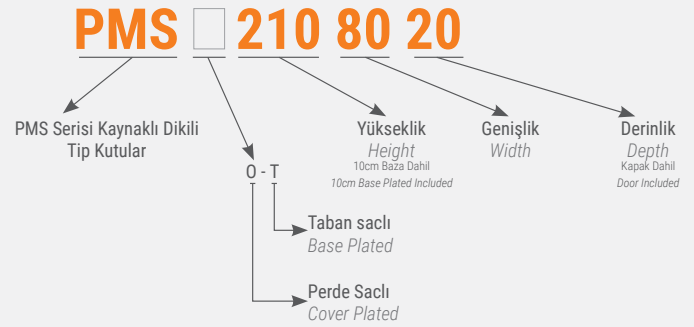

Sıva Altı Kutular (PMA Serisi)

lush Mounted Boxes (PMA Series)



ÖZELLİKLER

- IP41'e kadar koruma
- IEC 61439-2 ve IEC 62208 standartlarına uygun
- Galvaniz kaplı çelik;
Gövde: 1-1.5mm / Ral 7035 Boyalı
Ön Kapak: 1-1.5mm / Ral 7035 Boyalı

STANDART AKSESUARLAR

- Taşıyıcı mapa
 - İspanyolet kilit sistemi ve gizli menteşe sistemi
 - Çeyrek Dönüslü kilit
 - Projecebi
 - Alüminyum kablo giriş fırçası
- Ek Aksesuarlar; 01-03-04-05-12-14-15-16-17-18

FEATURES

- Up to IP41 protection
- Compatible with IEC 61439-1/2 ve IEC 62208 standards
- Galvanized Steel;
Body: 1-1.5mm / Ral 7035 painted
Front Door: 1-1.5 / Ral 7035 painted

STANDARD ACCESSORIES

- Transport Lug
 - Espagnolette Lock system and concealed hinge system
 - Quarter Turn Lock
 - Projecebi / Document pocket
 - Aluminium cable entry brush
- Addible Accesories; 01-03-04-05-12-14-15-16-17-18



Gövde etrafında 5cm çerçeve ve gövde içine gömme kapak
5cm frame around the body and recessed door in the body



Kapak bölme seçenekleri
Door seperation options

Ürün Kodu Product Code	Yükseklik Height	Genişlik Width	Derinlik Depth	
404012	400 mm	400 mm	120 mm	
404015			150 mm	
604012	600 mm	400 mm	120 mm	
604015			150 mm	
605012		500 mm	120 mm	
605015			150 mm	
804012	800 mm	400 mm	120 mm	
804015			150 mm	
805012		500 mm	120 mm	
805015			150 mm	
806012		600 mm	120 mm	
806015			150 mm	
1004012		1000 mm	400 mm	120 mm
1004015				150 mm
1005012	500 mm		120 mm	
1005015			150 mm	
1006012	600 mm		120 mm	
1006015			150 mm	
1008012	800 mm		120 mm	
1008015			150 mm	

Ürün Kodu Product Code	Yükseklik Height	Genişlik Width	Derinlik Depth
1204012	1200 mm	400 mm	120 mm
1204015			150 mm
1205012		500 mm	120 mm
1205015			150 mm
1206012		600 mm	120 mm
1206015			150 mm
1208012		800 mm	120 mm
1208015			150 mm
1404012	1400 mm	400 mm	120 mm
1404015			150 mm
1405012		500 mm	120 mm
1405015			150 mm
1406012		600 mm	120 mm
1406015			150 mm
1408012		800 mm	120 mm
1408015			150 mm

Kutu Yükseliği (Çerçeve Hariç) Box Height (Except Frame)	Perde Sacı Toplam Yüksekliği Cove Plate Height
80cm	75cm
100cm	95cm

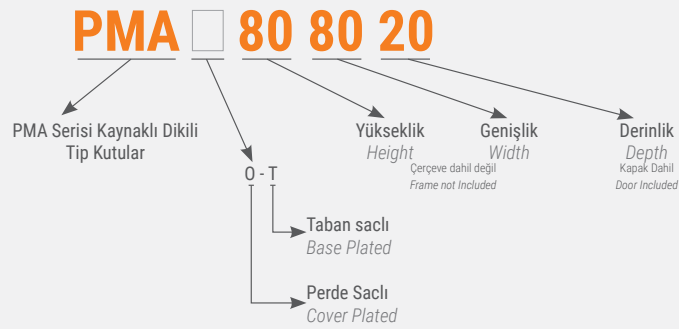

Daire Panoları (PMD Serisi)

Boxes for Residences (PMD Series)



Dikey Siva Altı Daire Panoları
Decorative vertical flush mounted boxes



Yatay Siva Altı Daire Panoları
Horizontal flush mounted boxes



Siva Üstü Daire Panoları
Decorative wall type boxes

Dekoratif Sıva Altı Kutular (PMF Serisi)

Decorative Flush Mounted Boxes (PMF Series)



SIVA ALTI ÖZEL DEKORATİF PANOLAR



Ürün Kodu Product Code	Açıklama Description
PIK SA 1005-01	1 Sıra x 13 Otomat / Buzlu Plastik Kapaklı S
PIK SA 1005-02	2 Sıra x 12 Otomat / Buzlu Plastik Kapaklı S
PIK SA 1005-12	2 Sıra x 12 Otomat / Buzlu Plastik Kapaklı D
PIK SA 1005-03	3 Sıra x 14 Otomat / Buzlu Plastik Kapaklı S
PIK SA 1005-13	3 Sıra x 14 Otomat / Buzlu Plastik Kapaklı D
PIK SA 1005-33	3 Sıra x 18 Otomat / Buzlu Plastik Kapaklı D
PIK SA 1005-44	4 Sıra x 20 Otomat / Buzlu Plastik Kapaklı D
PIK SA 1007-01	1 Sıra x 13 Otomat / Renkli Plastik Kapaklı S
PIK SA 1007-02	2 Sıra x 12 Otomat / Renkli Plastik Kapaklı S
PIK SA 1007-12	2 Sıra x 12 Otomat / Renkli Plastik Kapaklı D
PIK SA 1007-03	3 Sıra x 14 Otomat / Renkli Plastik Kapaklı S
PIK SA 1007-13	3 Sıra x 14 Otomat / Renkli Plastik Kapaklı D
PIK SA 1007-33	3 Sıra x 18 Otomat / Renkli Plastik Kapaklı D
PIK SA 1007-44	4 Sıra x 20 Otomat / Renkli Plastik Kapaklı D
PIK SA 1013-02	2 Sıra x 12 Otomat / Renkli Plastik Kapaklı S
PIK SA 1013-12	2 Sıra x 12 Otomat / Renkli Plastik Kapaklı D
PIK SA 1013-03	3 Sıra x 14 Otomat / Renkli Plastik Kapaklı S
PIK SA 1013-13	3 Sıra x 14 Otomat / Renkli Plastik Kapaklı D
PIK SA 1013-33	3 Sıra x 18 Otomat / Renkli Plastik Kapaklı D
PIK SA 1013-44	4 Sıra x 20 Otomat / Renkli Plastik Kapaklı D

KUTU ÖLÇÜLERİ

Otomat Sayısı	Çerçeve Ölçüsü (Boy x En)	Çerçeve Ölçüsü (Boy x En)
1 x 13	235 x 355	204 x 278
2 x 12	364 x 323	344 x 278
3 x 14	471 x 370	441 x 329
3 x 18	571 x 435	541 x 396
4 x 20	718 x 484	692 x 448

S = Dar otomat rayı etrafında 85 mm kablo geçiş boşluğu

D = Derin otomat rayı arkasından 95 mm kablo geçiş boşluğu

Buat Kutuları (PBK T Serisi)

Terminal Boxes (PBK T Series)



ÖZELLİKLER

- IP65'e kadar koruma
- IEC 61439-2 ve IEC 62208 standartlarına uygun
- Vidalı kapak / Poliüretan Conta
- Galvaniz kaplı çelik;
Gövde: 1-1.5mm / Ral 7035 Boyalı
Ön Kapak: 1-1.5mm / Ral 7035 Boyalı

FEATURES

- Up to IP65 protection
- Compatible with IEC 61439-1/2 ve IEC 62208 standards
- Screw mount cover / Polyurethan Gasket
- Galvanized Steel;
Body: 1-1.5mm / Ral 7035 painted
Front Door: 1-1.5 / Ral 7035 painted

Ürün Kodu Product Code	Yükseklik Height	Genişlik Width	Derinlik Depth
PBK T 202015	200 mm	200 mm	150 mm
PBK T 302015	300 mm	200 mm	150 mm
PBK T 303015	300 mm	300 mm	150 mm
PBK T 402015	400 mm	200 mm	150 mm
PBK T 403015	400 mm	300 mm	150 mm
PBK T 404015	400 mm	400 mm	150 mm

Kutu Genişliği Box Width	Taban Sacı Yüksekliği Base Plate Height	Kutu Genişliği Box Width	Taban Sacı Genişliği Base Plate Width
20cm	16cm	30cm	26cm
300cm	26cm	40cm	36cm

Şantiye Panoları (PMH S Serisi)

Construction Boards (PMH S Series)



Taşıyıcı ayak yapısı
Carrier leg structure



Prizleri koruyan ve çift taraflı kapak yapısı
Double-sided and protective cover system for sockets



ÖZELLİKLER

- IP41'e kadar koruma
- PM serisi iç parçaları ile uyumlu
- Galvaniz kaplı çelik;
Gövde: 1-1.5mm / Ral 7035 Boyalı
Ön Kapak: 1-1.5mm / Ral 7035 Boyalı
Taşıyıcı Ayak: 2mm / Ral 7035 Boyalı

FEATURES

- Up to IP41 protection
- Compatible with PM series internal parts
- Galvanized Steel;
Body: 1-1.5mm / Ral 7035 painted
Front Door: 1-1.5 / Ral 7035 painted
Carrier system: 2mm / Ral 7035 painted

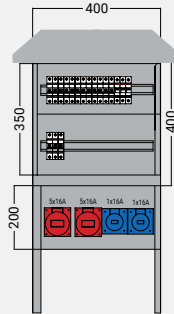

Pano Tipi/ Pano Kodu:
Panel Type/Panel Code:
TIP-1/ POK SP 754030

Pano Açıklaması / Panel Description
(400+350) X 400 X 300 mm
4T + 4M

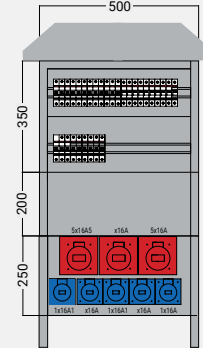

Pano Tipi/ Pano Kodu:
Panel Type/Panel Code:
TIP-2/ POK SP 1005030

Pano Açıklaması / Panel Description
(600+400) X 500 X 300 mm
6T + 10M

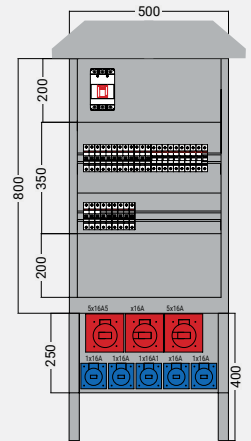

Pano Tipi/ Pano Kodu:
Panel Type/Panel Code:
TIP-3/ POK SP 1205030

Pano Açıklaması / Panel Description
(800+400) X 500 X 300mm
6T + 10M

Kaynaklı Dikili Tip Sayaç Panoları (PSK S Serisi)

Monoblock Floor Standing Type Meter Panels (PSK S Series)



Geçmeli ve mühürlenilebilir perde sacları
Flip-off and sealable cover plate



Farklı kapı seçenekleri
Different type of doors

ÖZELLİKLER

- IP41'e kadar koruma
- IEC 61439-2 ve IEC 62208 standartlarına uygun
- PS serisi iç parçaları ile uyumlu
- Galvaniz kaplı çelik;
Karkas: 1.2mm / Ral 7035 Boyalı
Kapı: 1.2mm / Ral 7035 Boyalı
Arka-Yan Kapak: 1mm / Ral 7035 Boyalı
Baza: 2mm / Ral 9005 Boyalı

FEATURES

- Up to IP41 protection
- Compatible with IEC 61439-1/2 ve IEC 62208 standards
- Compatible with PS series internal parts
- Galvanized Steel;
Structure: 1.2mm / Ral 7035 painted
Front Door: 1.2mm / Ral 7035 painted
Back-Side Covers: 1mm / Ral 7035 painted
Base carrier: 2mm / Ral 9005 painted

Ürün Kodu Product Code	Sayaç Tipi / Sayısı Meter Type / Unit	Yükseklik Height	Genişlik Width	Derinlik Depth
PSK S 2105040	Trifaze/Three-Phase 6 Sayaç	2100 mm	500 mm	400 mm
PSK S 2107040	Trifaze/Three-Phase 9 Sayaç	2100 mm	700 mm	400 mm
PSK S 2109040	Trifaze/Three-Phase 12 Sayaç	2100 mm	900 mm	400 mm
PSK S 21011040	Trifaze/Three-Phase 15 Sayaç	2100 mm	1100 mm	400 mm
PSK S 2105040	Monofaze/Single-Phase 12 Sayaç	2100 mm	500 mm	400 mm
PSK S 2106440	Monofaze/Single-Phase 16 Sayaç	2100 mm	640 mm	400 mm
PSK S 2107740	Monofaze/Single-Phase 20 Sayaç	2100 mm	770 mm	400 mm
PSK S 2109040	Monofaze/Single-Phase 24 Sayaç	2100 mm	900 mm	400 mm
PSK S 21010440	Monofaze/Single-Phase 28 Sayaç	2100 mm	1040 mm	400 mm
PSK S 21011740	Monofaze/Single-Phase 32 Sayaç	2100 mm	1170 mm	400 mm

Duvar Tipi Sayaç Kutuları (PMK S Serisi)

Monoblock Meter Boxes (PMK S Series)



Geçmeli ve mühürlenebilir perde sacları
Flip-off and sealable cover plate



Farklı kapı seçenekleri
Different type of doors

ÖZELLİKLER

- IP41'e kadar koruma
- IEC 61439-2 ve IEC 62208 standartlarına uygun
- PM serisi iç parçaları ile uyumlu
- Galvaniz kaplı çelik;
Gövde: 1mm / Ral 7035 Boyalı
Kapı: 1mm / Ral 7035 Boyalı
Baza: 1,5mm / Ral 9005 Boyalı

ÖZELLİKLER

- Up to IP41 protection
- Compatible with IEC 61439-1/2 ve IEC 62208 standards
- Compatible with PM series internal parts
- Galvanized Steel;
Body: 1mm / Ral 7035 painted
Front Door: 1mm / Ral 7035 painted
Base carrier: 1.5mm / Ral 9005 painted

Ürün Kodu Product Code	Sayaç Tipi / Sayısı Meter Type / Unit	Yükseklik Height	Genişlik Width	Derinlik Depth
PIK S O 1602420	Trifaze/Three-Phase 2 Sayaç	1600 mm	240 mm	200 mm
PIK S O 1604420	Trifaze/Three-Phase 4 Sayaç	1600 mm	440 mm	200 mm
PIK S O 1606420	Trifaze/Three-Phase 6 Sayaç	1600 mm	640 mm	200 mm
PIK S O 1608420	Trifaze/Three-Phase 8 Sayaç	1600 mm	840 mm	200 mm
PIK S O 16010420	Trifaze/Three-Phase 10 Sayaç	1600 mm	1040 mm	200 mm
PIP S O 1301820	Monofaze/Single-Phase 2 Sayaç	1300 mm	180 mm	200 mm
PIP S O 1601820	Monofaze/Single-Phase 3 Sayaç	1600 mm	180 mm	200 mm
PIP S O 1603120	Monofaze/Single-Phase 6 Sayaç	1600 mm	310 mm	200 mm
PIP S O 1604420	Monofaze/Single-Phase 9 Sayaç	1600 mm	440 mm	200 mm
PIP S O 1605820	Monofaze/Single-Phase 12 Sayaç	1600 mm	580 mm	200 mm
PIP S O 1607120	Monofaze/Single-Phase 15 Sayaç	1600 mm	710 mm	200 mm
PIP S O 1608420	Monofaze/Single-Phase 18 Sayaç	1600 mm	840 mm	200 mm
PIP S O 16010720	Monofaze/Single-Phase 21 Sayaç	1600 mm	1070 mm	200 mm

Piyano Panolar (PPY T Serisi)

Piano Type Enclosures (PPY T Series)

ÖZELLİKLER

- Modüler üst gövde yapısı
- IP 54'e kadar koruma
- Galvaniz kaplı çelik;
Gövde: 1.5mm
Kapı: 1.5mm
Taban sacı: 2mm

STANDART AKSESUARLAR

- İspanyolet kilit sistemi ve gizli menteşe sistemi
- Kapak sabitleyici
- Projecebi
- Poliüretan Conta

FEATURES

- Modular upper body
- Up to IP 54 protection
- Galvanized Steel;
Body: 1.5mm
Door: 1.5mm
Base plate: 2mm

STANDARD ACCESSORIES

- Espagnolette Lock system and concealed hinge system
- Door stopper
- Projecebi / Document pocket
- Polyurethan Gasket



Sabitlebilir üst kapaklar
Fixible upper doors



Çift taraflı taban sacı
Double-sided base plate

Ürün Kodu Product Code	Yükseklik Height	Genişlik Width	Derinlik Depth
1206040	1200 mm	600 mm	400 mm
1206050			500 mm
1208040		800 mm	400 mm
1208050			500 mm
12010040		1000 mm	400 mm
12010050	500 mm		
1306040	1300 mm	600 mm	400 mm
1306050			500 mm
1308040		800 mm	400 mm
1308050			500 mm
13010040		1000 mm	400 mm
13010050	500 mm		
1406040	1400 mm	600 mm	400 mm
1406050			500 mm
1408040		800 mm	400 mm
1408050			500 mm
14010040		1000 mm	400 mm
14010050	500 mm		

Kabin Yüksekliği Enclosure Height	Taban Sacı Yüksekliği Base Plate Height	Üst Taban Sacı Yüksekliği Top Base Plate Height
120cm	47cm	40cm
Kabin Genişliği Enclosure Width	Taban Sacı Genişliği Base Plate Width	Üst Taban Sacı Genişliği Top Base Plate Width
80cm	70cm	74cm

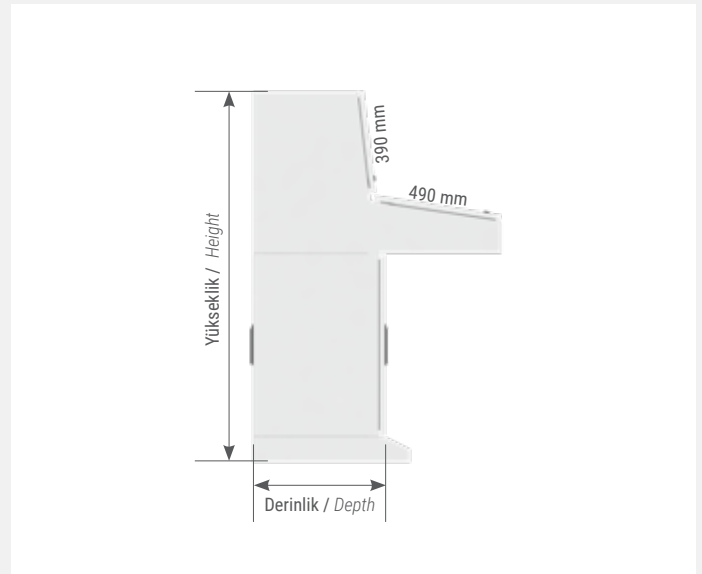

Pult Tipi Piyano Panolar (PPT T Serisi)

Pult Piano Type Enclosures (PPT T Series)

ÖZELLİKLER

- Modüler üst gövde yapısı
- IP 54'e kadar koruma
- Galvaniz kaplı çelik;
Gövde: 1.5mm
Kapı: 1.5mm
Taban sacı: 2mm

STANDART AKSESUARLAR

- İspanyolet kilit sistemi ve gizli menteşe sistemi
- Kapak sabitleyici
- Projecebi
- Poliüretan Conta
- Alüminum kablo giriş fırçası/

FEATURES

- Modular upper body
- Up to IP 54 protection
- Galvanized Steel;
Body: 1.5mm
Door: 1.5mm
Base plate: 2mm

STANDARD ACCESSORIES

- Espagnolette Lock system and concealed hinge system
- Door stoper
- Projecebi / Document pocket
- Polyurethan Gasket
- Aluminium cable entry brush



Sabitlenebilir üst kapak
Fixible upper door

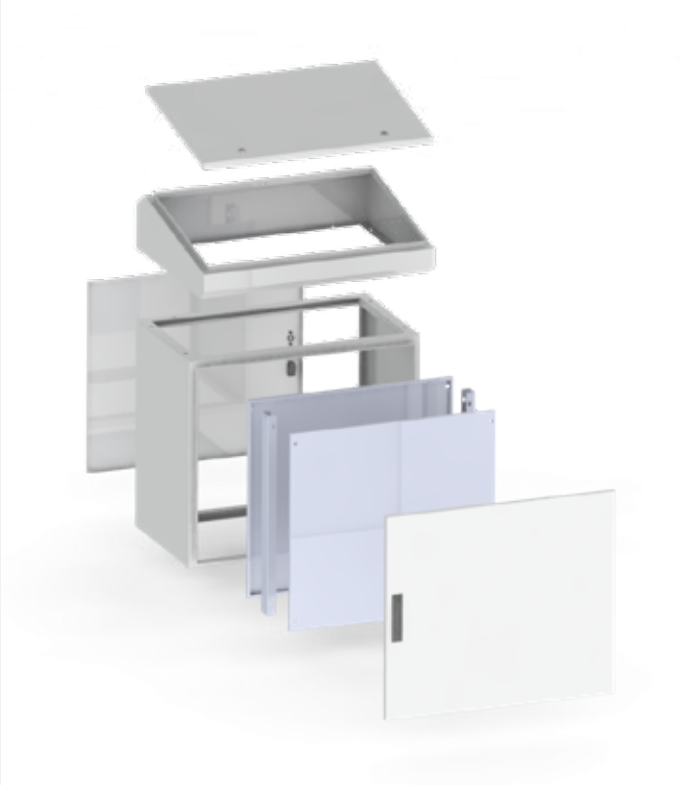

Çift taraflı taban sacı
Double-sided base plate

Ürün Kodu Product Code	Yükseklik Height	Genişlik Width	Derinlik Depth
906040	900 mm	600 mm	400 mm
906050			500 mm
908040		800 mm	400 mm
908050			500 mm
1006040	1000 mm	600 mm	400 mm
1006050			500 mm
1008040		800 mm	400 mm
1008050			500 mm
1106040	1100 mm	600 mm	400 mm
1106050			500 mm
1108040		800 mm	400 mm
1108050			500 mm
11010040		100 mm0	400 mm
11010050			500 mm
1206040	1200 mm	600 mm	400 mm
1206050			500 mm
1208040		800 mm	400 mm
1208050			500 mm
12010040		100 mm0	400 mm
12010050			500 mm

Kabin Yüksekliği Enclosure Height	Taban Sacı Yüksekliği Base Plate Height	Kabin Genişliği Enclosure Width	Taban Sacı Genişliği Base Plate Width
100cm	67cm	80cm	71cm

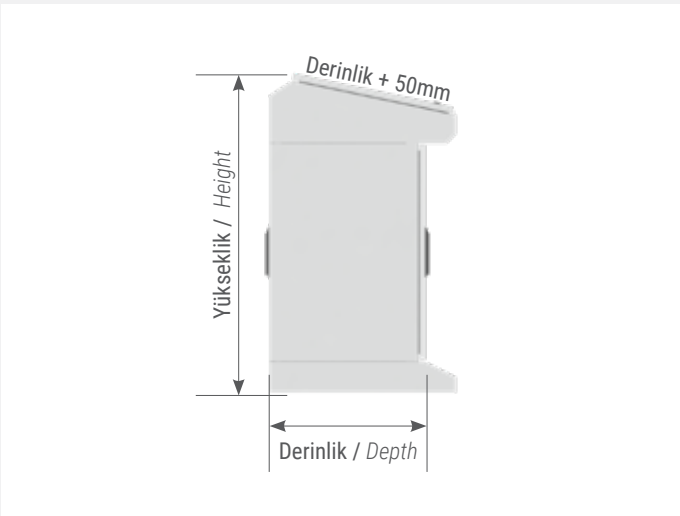

Operatör Kollar

Panel Holders



Ürün açıklaması;

OP Serisi Kontrol panvrtaamlarda Operatör kol takımına sabitlenerek kullanılmak üzere tasarlanmıştır. Birçok pano uygulamasında kullanılmasın uygun olacak şekilde işlevsel ve ekonomik çözümler sunmaktadır. Dış ortam ile temas edecek bölümleri galvaniz kaplı sac üzeri toz boya ile kaplanmış, dış kapakları da poliüretan conta sistemi ile çevrelenmiştir. Bu sayede yüksek korozyon dayanımı ve sızdırmazlık sağlamaktadır.

Kullanım Yeri : Dahili – İç Ortam

Koruma Sınıfı : IP 40 / IK 10

Sac Kalınlığı / Cinsi : Gövde; 1,5mm / Galvaniz kaplı sac üzeri toz boya

Kapaklar 1,5mm / Galvaniz kaplı sac üzeri toz boya

İç montaj elemanları; 1,5mm / Galvaniz kaplı sac

Örtü sacları; 1mm / Galvaniz kaplı sac üzeri toz boya

Boya / Boya Rengi : Epoksi-polyster toz boya / Standart Ral 7035

Standartlar : IEC 61439-1, IEC 62208, IEC 60529, IEC 62262

Product Description;

OP series control panels designed to used in indoor applications and desinged to mount by mounting ears to wall. In many machine and automation applications it provides functional and economic solutions. The parts that has contact with outside are made by powder coated galvanized steel and the doors frames are surrounded by Polyurethane gasket. Thus this serie provides high corosion resistance and protection

Usage area : Indoor

Protection Class : IP 40 / IK 10

Metal Thickness / Type : Body; 1,5mm / powder coated Galvanized Steel

Covers; 1,5mm / powder coated Galvanized Steel

Internal Mounting parts; 2mm / Galvanized Steel

Cover plates; 1mm / powder coated Galvanized Steel

Paint Type / Paint Color : Epoxy-polyster powder coating / Standart Ral 7035

Standarts : IEC 61439-1, IEC 62208, IEC 60529, IEC 62262

Operatör Kollar

Panel Holders

MB1 360° hareketli / 360° movable

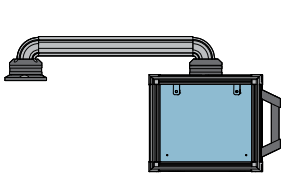

1

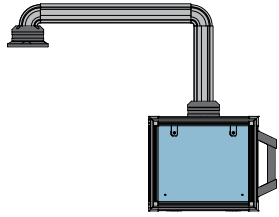

2

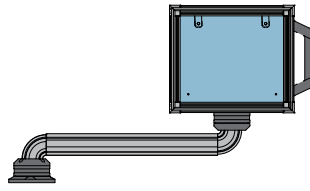

3

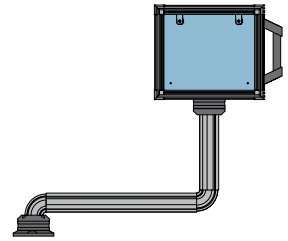

4

MB2 360° hareketli / 360° movable

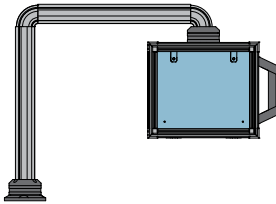

5

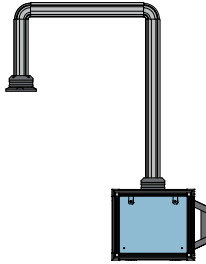

6

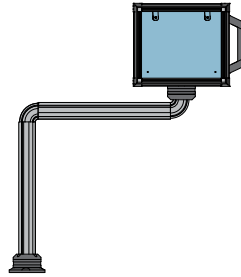

7

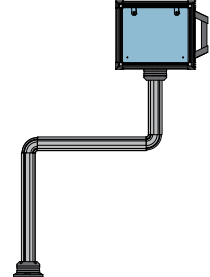

8

MB3 360° hareketli / 360° movable

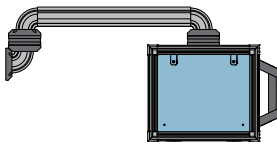

9

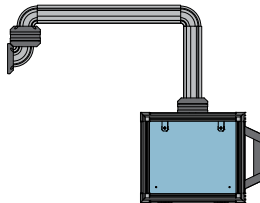

10

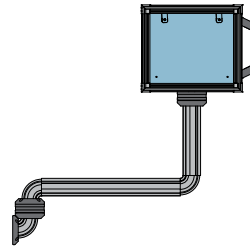

11

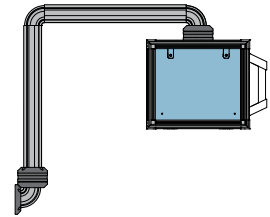

12

MB4 Sabit / Fixed

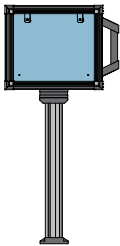

13

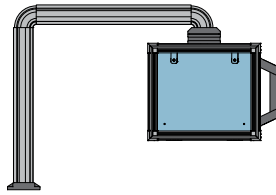

14

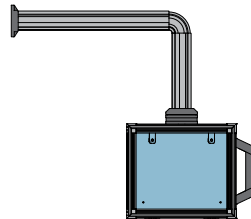

15

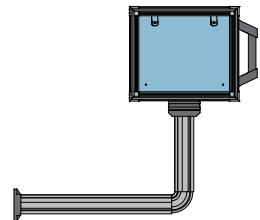

16

Operatör Paneller

Operating Panels



ÖNDEN KAPALI

Ürün Kodu	Açıklama	Ölçüler
POP 01.01	350x390x140 mm Menteşe Kapaklı Operatör Panel/ <i>Hinged Covered Operating Panel</i>	4.3" - 10"
POP 01.02	420x460x140 mm Menteşe Kapaklı Operatör Panel/ <i>Hinged Covered Operating Panel</i>	10" - 15"

Çeyrek dönüşlü zamak kilit ve gizli menteşe sistemi
Alüminyum taşıma kulpu
IP54'e kadar koruma
1.5mm kalınlıkta galvaniz kaplı gövde ve kapak

*Quarter turn lock and concealed hinge system
Aluminium carrier handle
Up to IP 54 protection
1.5mm thickness galvanized steel body and cover*

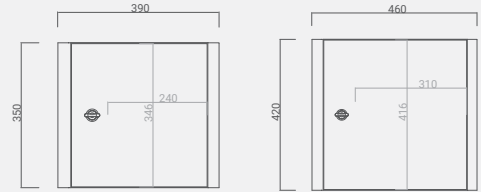

ÖNDEN VİDA KAPAKLI

Ürün Kodu	Açıklama	Ölçüler
POP 02.01	350x390x140 mm Vida Kapaklı Operatör Panel <i>Screw Mounted Covered Operating Panel</i>	4.3" - 10"
POP 02.02	420x460x140 mm Vida Kapaklı Operatör Panel <i>Screw Mounted Covered Operating Panel</i>	10" - 15"

Vidalı kapak
Alüminyum taşıma kulpu
IP54'e kadar koruma
1.5mm kalınlıkta galvaniz kaplı gövde
2mm kalınlıkta alüminyum montaj kapağı

*Screw mount cover
Aluminium carrier handle
Up to IP 54 protection
1.5mm thickness galvanized steel body
2mm thickness aluminium mounting cover*

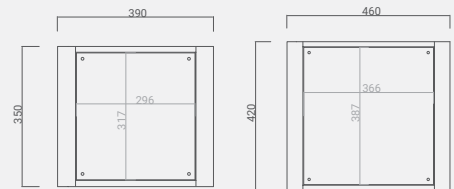

PİYANO ÖNDEN VİDA KAPAKLI

Ürün Kodu	Açıklama	Ölçüler
POP 03.01	(350+200)x390x140 mm Vida Kapaklı Piyano Operatör Panel <i>Screw Mounted Covered Piano Operating Panel</i>	4.3" - 10"
POP 03.02	(420+200)x460x140 mm Vida Kapaklı Piyano Operatör Panel <i>Screw Mounted Covered Piano Operating Panel</i>	10" - 15"

Vidalı kapak
Alüminyum taşıma kulpu
IP54'e kadar koruma
1.5mm kalınlıkta galvaniz kaplı gövde
2mm kalınlıkta alüminyum montaj kapağı

*Screw mount cover
Aluminium carrier handle
Up to IP 54 protection
1.5mm thickness galvanized steel body
2mm thickness aluminium mounting cover*

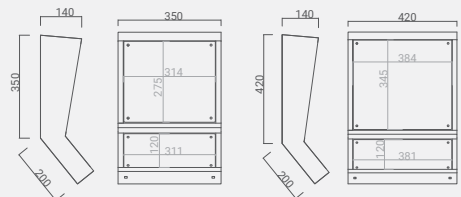

Operatör Paneller

Operating Panels



ÖNDEN KAPALI ALÜMİNYUM KAPAKLI

Ürün Kodu	Açıklama	Ölçüler
POP 04.01	350x390x140 mm Arkadan Menteşe Kapaklı Operatör Panel <i>Back Side Hinged Covered Operating Panel</i>	4.3" - 10"
POP 04.02	420x460x140 mm Arkadan Menteşe Kapaklı Operatör Panel <i>Back Side Hinged Covered Operating Panel</i>	10" - 15"

Çeyrek dönüşlü zamak kilit ve gizli menteşe sistemi
Vidalı ön kapak
Ön tarafı alüminyum kapak takmaya uygun
IP54'e kadar koruma
1.5mm kalınlıkta galvaniz kaplı gövde ve kapak
2mm kalınlıkta alüminyum montaj kapağı

*Quarter turn lock and concealed hinge system
Screw mount front cover
The front side is suitable to mount aluminium cover
Up to IP 54 protection
1.5mm thickness galvanized steel body and cover
2mm thickness aluminium mounting cover*

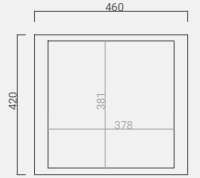
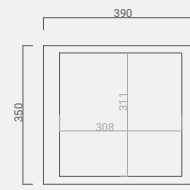

ALÜMİNYUM PANO

Ürün Kodu	Açıklama	Ölçüler
POP 05.01	Bütün ölçülerde üretilebilir <i>Can be produced in all sizes</i>	4.3" - 10"

Çeyrek dönüşlü zamak kilit ve gizli menteşe sistemi
Vidalı ön kapak
IP54'e kadar koruma
Komple alüminyum gövde
2mm kalınlıkta alüminyum montaj kapağı

*Quarter turn lock and concealed hinge system
Screw mount front cover
Up to IP 54 protection
Completely aluminium body
2mm thickness aluminium mounting cover*

Aksesuarlar

Accessories



13 - Çeyrek Dönüşlü kilit
Quarter Turn Lock



14 - Otomat Rayı
MCB Rail



15 - Kablo Kanalı
Cable Trays



16 - Termostat
Thermostat



17 - Aydınlatma
Lightning



18 - Kapı Sivici
Door Switch



19 - Hava Filtresi
Air Filter



20 - Fan
Fan
12x38cm, 17x50cm, 25x25cm



11 Doğal havalandırma modülü
Natural ventilation modul

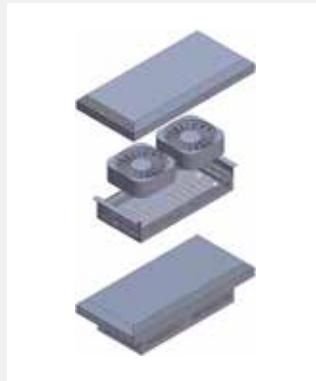

12 Çiftli fan modülü
Double fan modul



13 Fan modülü
Fan modul



24 - Projecebi
Document Pocket

Kullanım Alanları

Usage Areas

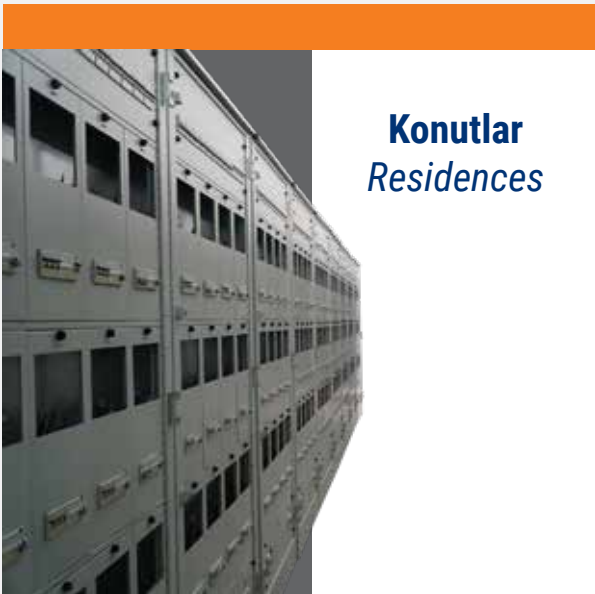
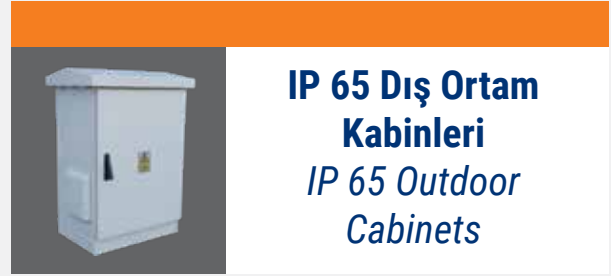



Cihangir Mah. Güvercin Cad. No. 15/1
Avcılar - İSTANBUL / TÜRKİYE

T: +90 212 494 28 82 Pbx

info@pinopano.com
www.pinopano.com

 **PINO PANO**

